

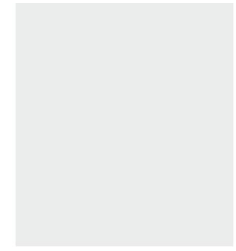

E-mail : info@halax.in
www.halax.in

Glass Architectural Hardware



Delivering Symmetrical Elegance For Aesthetic Resonance HALAX has been an innovative and professional company engaged in research, development, manufacture and marketing of fittings for architectural hardware. HALAX supplies fittings of high quality and provides consulting services to the architectural industry. Through many years development, HALAX achieves a good reputation in Construction Industry and Hard wore Industry. Unique value con only be created by professionalism. speculation has no future. This motto is practiced by HALAX personnel at all levels, ranging from senior executives to the new entry employees. In the continuous quest for constant technology development, higher quality and better services, today HALAX has become the prominent and largest supplier of fittings for architectural hardware industry.

Striving to become the leader to serve the architectural hardware industry in the world, HALAX not only adopts advanced management and manufacturing method, but also invests heavily in design and innovation. Rich product and prominent capability of innovation is the driving force for its progress. The company has achieved acclaim in innovative design, elegant appearance, high quality products and unsurpassed services, greatly meets the individual needs of different customers, and is widely praised by customers. HALAX takes pride in supplying fillings to many famous landmarks in countless cities of all over the world.

HALAX is always your best and most reliable partner in supplying fillings for architectural hardware.

A large, faded version of the HALAX logo, consisting of the word 'HALAX' in a light grey, sans-serif font with a registered trademark symbol (®) at the end.

INDEX



Page No.

1-3	Floor Hinges
3	Hydraulic Floor Hinges
4-6	Patch Fittings
6	Door Closers
7-8	Shower Hinges
9	Glass Connectors
10-11	Shower Knight Head Accessories
12	Plastic Profile
13	Glass Door Handles
14-15	Glass Door Locks
16-18	Office & Residential Sliding System
19-20	Shower Sliding System
21	Sliding Folding System
22	Frameless Center Folding System
23	Glass Folding System
25	Artificial Marble Ledge
26	Telescopic Frameless Glass Doors
27	Fin Plates & Splice Plates
28-29	Spider Fittings
30	Canopy Fittings
31	Railing Accessories
32	Digital Lock & Smart Sliding Locks
33	Automatic Openable Door System
34-35	Slim Profile System
36	Automatic Sliding Sensor Door



 Tested **500,000** Cycles
 Weight Carrying Capacity



FHHS 3080H

Single Cylinder
Floor Hinge Maximum bearing weight-80kgs

Specification :

- Over 500,000 cycles tested.
- General design, suitable for left or right hand to open the door in single and both sides.
- Universal machine cylinder.
- Closing force-15nm.
- Maximum wide door leaf-900mm.
- Maximum bearing weight -80Kgs.
- Speed covering control-two stage adjustable speed.
- Location-90° hold open.

 Tested **500,000** Cycles
 Weight Carrying Capacity



HFH-84

Single Cylinder
Floor Hinge Maximum bearing weight-90kgs

Specification :

- Over 500,000 cycles tested.
- General design, suitable for left or right hand to open the door in single and both sides.
- Universal machine cylinder.
- Closing force-15nm.
- Maximum wide door leaf-900mm.
- Maximum bearing weight -90Kgs.
- Speed covering control-two stage adjustable speed.
- Location-90° hold open.

 Tested **500,000** Cycles
 Weight Carrying Capacity



HFH-8401

Double Cylinder
Floor Hinge Maximum bearing weight-90kgs

Specification :

- Over 500,000 cycles tested.
- General design, suitable for left or right hand to open the door in single and both sides.
- Universal machine cylinder.
- Closing force-25nm.
- Maximum wide door leaf-1100mm.
- Maximum bearing weight -90Kgs.
- Speed covering control-two stage adjustable speed.
- Location-90° hold open.

S series Combo
Floor Hinge
Top Patch
Bottom Patch
Patch Lock
Pivot
H-Handle

 Tested **500,000** Cycles
 Weight Carrying Capacity



HFH-8400

Double Cylinder
Floor Hinge Maximum bearing weight-90-120kgs

Specification

- Over 500,000 cycles tested.
- General design, suitable for left or right hand to open the door in single and both sides.
- Universal machine cylinder.
- Closing force-25nm.
- Maximum wide door leaf-1100mm.
- Maximum bearing weight -90-120Kgs.
- Speed covering control-two stage adjustable speed.
- Location-90° hold open.

HFH-8400
● Black
● Golden
● Rose Gold



Tested **500,000** Cycles

Weight Carrying Capacity **90-120 Kg**

HFH-8600EH	
● Black	
● Golden	
● Rose Gold	

HFH-8600EH

Double Cylinder
Floor Hinge Maximum bearing weight-90-120kgs

Specification :

- Over 500,000 cycles tested.
- General design, suitable for left or right hand to open the door in single and both sides.
- Universal machine cylinder.
- Closing force-25nm.
- Maximum wide door leaf-1100mm.
- Maximum bearing weight -90-120Kgs.
- Speed covering control-two stage adjustable speed.
- Location-90° hold open.



Tested **500,000** Cycles

Weight Carrying Capacity **270 Kg**

HFH-10400

Single Cylinder
Floor Hinge Maximum bearing weight-270kgs

Specification :

- Over 500,000 cycles tested.
- General design, suitable for left or right hand to open the door in single and both sides.
- Universal machine cylinder.
- Closing force-35nm.
- Maximum wide door leaf-1250mm.
- Maximum bearing weight -270Kgs.
- Speed covering control-two stage adjustable speed.
- Location-90° hold open.



Tested **500,000** Cycles

Weight Carrying Capacity **90-120 Kg**



HFH-1200

Double Cylinder
Floor Hinge Maximum bearing weight-90-120kgs

Specification :

- Over 10,00,000 cycles tested.
- General design, suitable for left or right hand to open the door in single and both sides.
- Universal machine cylinder.
- Closing force-25nm.
- Maximum wide door leaf-1100mm.
- Maximum bearing weight -90-120Kgs.
- Speed covering control-two stage adjustable speed.
- Location-90° hold open.

HYDRAULIC FLOOR HINGES

HHFH - 100

Hydraulic Floor Hinge



Specification :

- Suitable door weight : Max 100kg
- Suitable door width : 750-100mm
- Suitable door thickness : 8-13 mm
- Ambient temperature : -20°C~+50°C
- Quick and easy installation

HPF - 101

Hydraulic Floor Hinge, Top Patch & Pivot Set



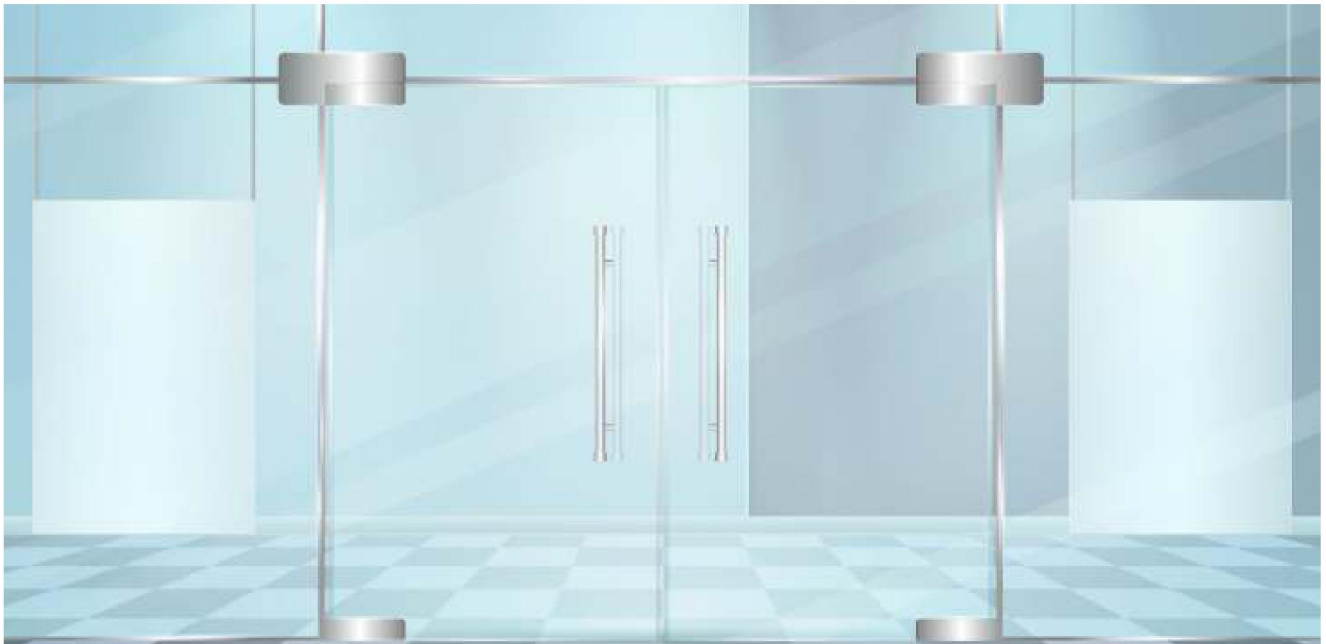

■ B ■ G ■ RG



HPL-1
Patch Lock



HPL-2A
Centre Patch Lock



HPL-2B
Centre Strike Box

■ B ■ G ■ RG



HPF-2
Top Patch

■ B ■ G ■ RG



HPF-3
Bottom Patch

■ B ■ G ■ RG



HPF-4
Over Panel Patch with Pivot

■ B ■ G ■ RG



HPF-4A
Over Panel Pivot Patch
with Fin for 10mm to 12mm



HPF-1
Over Panel & Side Panel
Patch with Pivot (Big L)

■ B ■ G ■ RG



HPF-1A
Over Panel & Side Panel
Patch without Pivot (Big L)

■ B ■ G ■ RG



HPF-610
Over Panel & Side
Panel Patch (Small L)



HPF-610R
Over Panel & Side Panel Patch
(Small L with Right Fin)



HPF-610L
Over Panel & Side Panel Patch
(Small L with Left Fin)



HPF-610DS
Small L with Door Stopper



HPF-610DF
Small L with Back to Back Fin



HPF-620
Square Patch (Four Glass Connector)



HPF-620F
Square Patch with Fin (Four Glass Connector)



HPF-620DF
Square Patch with Back to Back Fin



HPF-650F
Two Glass Connector with Fin



HPF-640
Square Patch (Fix Structure/Wall to Glass)



HPF-650
Glass to Glass Patch Connector (Fix Structure/Wall to Glass)



HPF-660
Center Connector (Glass to Glass)



HPF-41L
Over Panel & Side Panel Patch (with Left Fin)



HPF-41R
Over Panel & Side Panel Patch (with Right Fin)



HPF-41DF
Over Panel & Side Panel Patch (with Back to Back Fin)



HPF-51
Double Over Panel Patch with Fin (for Back to Back Door)



HPF-51D
Double Over Panel Patch (for Back to Back Door)



HPL-3A
Latch Lock



HPL-3B
Strike Box



HWPD-1
Accessories for Wooden Doors



HMMH-3
Mini Floor Hinge



HGDP-1
Top Pivot



HGTB
Glass Tower Bolt



HGDS-1
Door Stopper

PATCH FITTINGS



3Mtr.

HRA-U25	
●	Black
●	Golden
●	Rose Gold

HRA-U25
Stainless Steel U Channel
Specifications :
U Channel

Firm seating with wall / floor
Good depth to hold glass
Available in standard size in 3000mm
Stainless Steel Grade 304
Finish: SSS
For 10mm & 12mm glass



HHFH-WD-100
Hydraulic Patch Fitting
For Wooden Door

DOOR CLOSERS



HDC-701
Round door closer



HDC-702
Triangle door closer



HDC-ND-02
Triangle door closer



HDC-703
Quadrangle door closer



HDC-ND-01
Round door closer



HDC-704-PLATE
Mounting Plate for Glass Door Installation
of Door Closer HDC-704

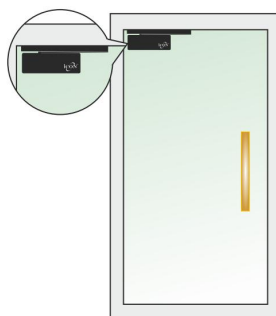

HDC-704
Overhead Door Closer Track Arm

Shower Hinges Commercial Series



HSH-1
Wall to Glass 90° Hinge (Brass/SS)



HSH-1SP
Wall to Glass 90°
Corner Hinge (Brass/SS)



HSH-2
Glass to Glass
180° Hinge (Brass/SS)



HSH-3
Glass to Glass 135°
Hinge (Brass/SS)



HSH-4
Glass to Glass 90° Hinge
(Brass/SS)



HSH-5
Wall to Glass 90°
Fixed Bracket (Brass/SS)



HSH-6
Double Glass Hinge Joint
with Fixed Glass (Brass/SS)



HSH-7
Pivot Hinge for Floor
Ceiling (Steel)

Shower Hinges Curve Series



HSH-11
Wall to Glass 90° Hinge
(Brass)



HSH-11SP
Wall to Glass 90° Corner
Hinge (Brass)



HSH-22
Glass to Glass 180°
Hinge (Brass)



HSH-33
Glass to Glass 135°
Hinge (Brass)



HSH-44
Glass to Glass 90°
Hinge (Brass)



HSH-55
Wall to Glass 90°
Fixed Bracket (Brass)



Shower Hinge Economy Series



HSH-11ES
Wall to Glass 90°
Hinge (Stainless Steel)



HSH-11ES-SP
Wall to Glass 90° Corner
Hinge (Stainless Steel)



HSH-22ES
Glass to Glass 180°
Hinge (Stainless Steel)



HSH-33ES
Glass to Glass 135°
Hinge (Stainless Steel)



HSH-44ES
Glass to Glass 90°
Hinge (Stainless Steel)



HSH-55ES
Wall to Glass 90° Fixed
Bracket (Stainless Steel)



Shower Hinge T-shower Hinge



HSH-66ES
Double Action 3-Way T-Shower Hinge

Specification:

- Maximum Glass Thickness: 8 & 10mm
- Maximum door width: 700mm
- Opening: inward (recommended) and outward
- Self-closing function activates once door reaches 30°
- SS 304 grade material
- Finish: PSS



HYDRAULIC SHOWER HINGES



HSH-15-SC-B
Wall to Glass (Hydraulic) 90° Black



HSH-15-SC
Wall to Glass (Hydraulic) 90°



Adjust the shaft arrow to the required strength position

(Twist The Arrow To The Position Of Desire Strength)

HSH-16-SC
Glass to Glass (Hydraulic) 180°



HGC-1
U Connector



HGC-2
Glass to Glass 135°



HGC-3
Glass to Glass 90°



HGC-4
Wall to Glass Connector



HGC-5
Glass to Glass 180°



HGC-6
T-Connector (Three Glass 90°/180° Connector)



HGC-444
Wall to Glass Connector Big (With Double Hole)

**** Available Color**

● Black
● Golden
● Rose Gold
● Antique Golden
● Antique Rose Gold

All Product Use In 10mm to 12mm Glass



HGC-1BL
U Connector



HGC-2BL
Glass to Glass 135°



HGC-3BL
Glass to Glass 90°



HGC-4BL
Wall to Glass Connector



HGC-5BL
Glass to Glass 180°



HGC-444BL
Wall To Glass Connector Big (With Double Hole)



SHOWER KNIGHT HEAD ACCESSORIES



HSKH-11
Wall to Track Connector



HSKH-33
Track Connector T-Type



HSKH-22
Glass to Track Connector



HSKH-44
90° Track Connector



HSKH-44A
Track to Track Connector
with Glass Clamp



HSKH-55
Shower Sliding
Track - 2mtr./3mtr.



HGH-19
Small Door Handle
Size : 19x171cc 152
19x248 cc 229



HGH-19A
Small Door Handle
Size : 19x171cc 152
19x248 cc 229



HGH-25
Square Door Handle
Size : 25x178 cc 153

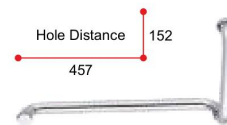

HGH-TB-1
Towel Bar Handle Round
Size : TB-1 (19mm) TB-2 (25mm)

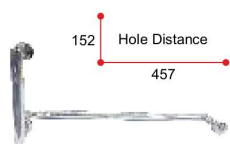

HGH-TB-1A
Towel Bar Handle Round
Size : (19mm)

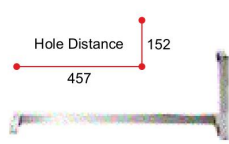

HGH-TB-11(SQ)
Towel Bar Handle Square

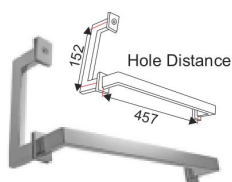

HGH-TB-11ES
Towel Bar Handle Rectangular



HGH-TBK-1
Tower Bar Handle with Knob
Size : 19x476 cc 457



HRB-1
Reinforcing Bar (Wall to Glass)
Size :890-1520
(maximum adjustment)

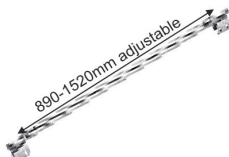

HRB-2
Reinforcing Bar (Glass to Glass)
Size :890-1520
(maximum adjustment)



HGH-TBK-11 SQ
Towel Bar Handle Square
Size : 25 x 476 cc 457

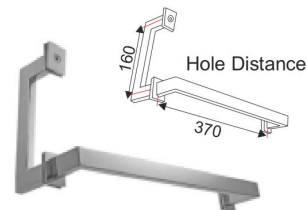

HGH-TB-22 RT
Towel Bar Handle Rectangular



HSKH-1
Wall to Rod



HSKH-2
Glass to Rod



HSKH-3
Rod to Rod (Jointer)



HSKH-4
Glass to Rod (End)



HSKH-5
Rod to Rod T Connector



HDK-1
Door Knob



HDK-2
Door Knob



HSKH-ACC-19
Connecting Tube Round (19mm)

Edge Line Shower Knight Head Accessories



HSKH-1-SL Std PSS
Wall to Track Connector



HSKH-2-SL Std PSS
Track to Glass Connector



HSKH-3-SL Std PSS
Glass to Track end Connector
Track to Track 90° Connector



HSKH-55-SL Std PSS
Connector Track

Available for 8, 10 & 12mm Glass Standard Length - 2.2mtr./2.5mtr.

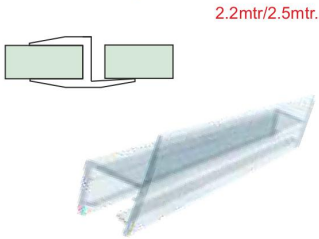

HPS-1
Side Seal

Thk.	Length
8/10mm	2.2m
12mm	2.2m
8/10mm	2.5m

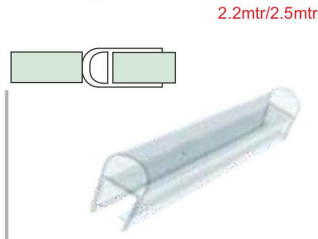

HPS-2
D Seal

Thk.	Length
8/10mm	2.2m
12mm	2.2m
8/10mm	2.5m

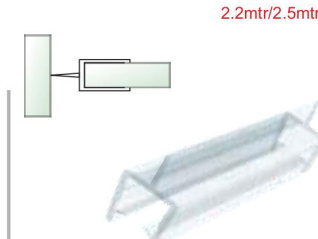

HPS-3
Centre Seal

Thk.	Length
8/10mm	2.2m
12mm	2.2m
8/10mm	2.5m

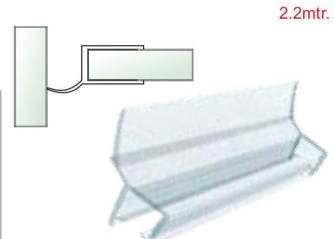

HPS-4
Wall to Glass 135° 2.2mtr.

Thk.	Length
8/10mm	2.2m
12mm	2.2m

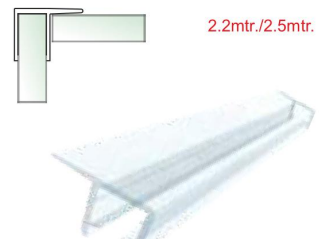

HPS-5
Sliding Door Seal (F)

Thk.	Length
8/10mm	2.2m
12mm	2.2m
10mm	2.5m

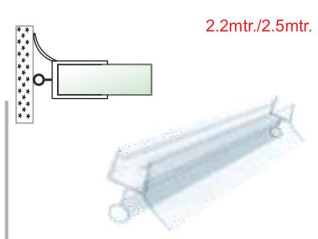

HPS-6
Water Dispersal Seal

Thk.	Length
8/10mm	2.2m
12mm	2.2m

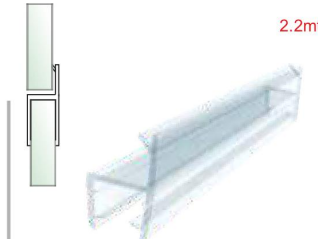

HPS-7
Side Seals with Lip 180°

Thk.	Length
8/10mm	2.2m

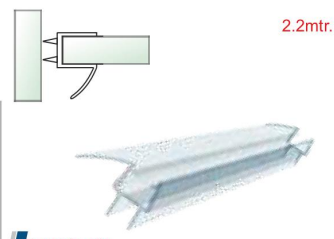

HPS-8
Water Dispersal Seals with Soft Centre Lip 2.2mtr.

Thk.	Length
8/10mm	2.2m

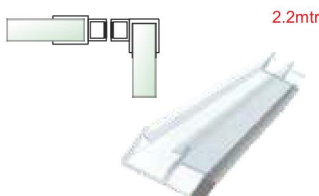

HPS-MS-180
Magnetic Seals 90°/180° for Sliding Door

Thk.	Length
8/10mm	2.2m
12mm	2.2m

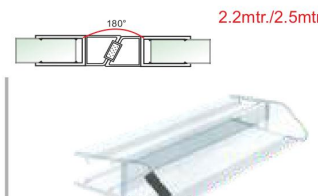

HPS-M-180
Magnetic Seals 180°

Thk.	Length
8/10mm	2.2m
12mm	2.2m
8/10mm	2.5m

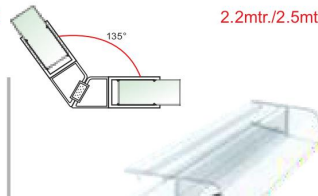

HPS-M-135
Magnetic Seals 135°

Thk.	Length
8/10mm	2.2m
12mm	2.2m
8/10mm	2.5m

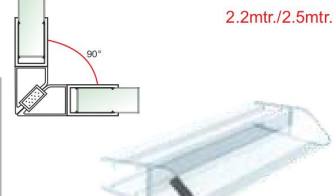

HPS-M-90
Magnetic Seals 90°

Thk.	Length
8/10mm	2.2m
12mm	2.2m
8/10mm	2.5m

Also Available in Black 2.5mtr.



HPS-BR
Brush Seal (Sliding Door)

Thk.	Length
12mm	2.5m



HPS-1B
Side Seal Black



HPS-2B
D Seal Black



HPS-5B
Sliding Door Seal (F) Black



HPS-M-180B
Magnetic Seals 180° Black



HGH-01S/PSS H Type Handle

- Black 32 x 450
- Golden 32 x 450
- Rose Gold 32 x 450

Sizes	CTC	Hole Dia
25 x 325	240	12
25 x 400	302	12
32 x 450	302	12
32 x 600	452	12
32 x 600	482	12
32 x 900	600	12
32 x 900	700	12
32 x 1200	900	12
32 x 1500	1200	12
32 x 1800	1500	12



HGH-02S/PSS D Type Handle

- Black
- Golden
- Rose Gold

Sizes	CTC	Hole Dia
25 x 327	302	12
25 x 400	375	12
32 x 450	418	12
32 x 600	568	12



HGH-03S/PSS S Type Handle

- Black
- Golden
- Rose Gold

Sizes	CTC	Hole Dia
32 x 450	302	12
32 x 600	450	12

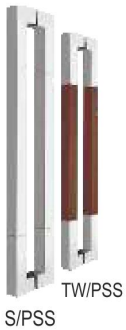

HGH-04

Sizes	CTC	Hole Dia
S/PSS		
25 x 327	302	12
30 x 484	454	12
30 x 630	600	12
TW/PSS		
25 x 327	302	12
30 x 484	454	12
30 x 630	600	12



HGH-05TW/PSS

Sizes	CTC	Hole Dia
15/30 x 350	280	12
25/45 x 450	302	12
25/45 x 550	302	12
25/45 x 800	12	12



HGH-06TW/PSS

Sizes	CTC	Hole Dia
38 x 500	302	12

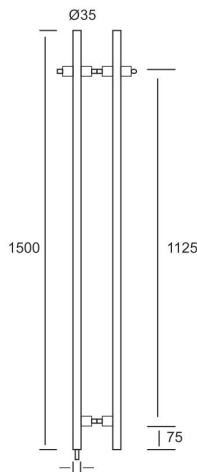

Lock with Handle

HGH-09

Sizes	CTC	Hole Dia
35 x 1500	1125	12



HGH-07S/PSS

Sizes	CTC	Hole Dia
25 x 327	302	12
32 x 486	454	12



HGH-08

Sizes	CTC	Hole Dia
S/PSS		
25 x 400	302	12
32 x 450	302	12
TW/PSS		
25 x 400	302	12
32 x 450	302	12



Adjustable

HGH-11

Sizes	CTC	Hole Dia
32 x 450		12
32 x 600		12



HGH-12

Sizes	CTC	Hole Dia
38 x 550		12
38 x 800		12

Please refer to actual product for glass cutout preparation.



HSL-1
Single Door Lock
(One Side Knob Only)



HSL-2
Double Door Lock
(One Side Knob Only)



HSL-3
Single Door Lock
(One Side Knob Only)



HSL-4
Double Door Lock
(One Side Knob Only)



HSL-5
Single Door Lock
(One Side Knob Only)



HSL-6
Double Door Lock
(One Side Knob Only)



HSL-7
Single Door Lock
(One Side Key One Side Knob)



HSL-8
Double Door Lock
(One Side Key One Side Knob)



HSL-9
Single Door Lock (One Side
Key One Side Knob)



HSL-9 A
Single Door Lock
(One Side Key Only)



HSL-9 B
Single Door Lock (Both Side Key)



HSL-10
Double Door Lock (One
Side Key One Side Knob)



HSL-10 A
Double Door Lock
(One Side Key Only)



HSL-10 B
Double Door Lock
(Both Side Key)



HSL-11
Single Door Lock
(One Side Key Only)



HSL-12
Double Door Lock
(One Side Key Only)



HSL-13
Sliding Glass Door Lock
(Glass To Wall/fix Structure With Strike Plate)



HSL-13 A
Sliding Glass Door Lock (Glass
To Glass Sliding Lock With Strike Box)



HGMH-1
Wall To Glass Door Lock (Glass
Door Lock with Mortise Handle)



HGMH-1 A
Glass Door Lock (Glass to Glass
Door Lock with Mortise Handle)

Glass Door Lock With Mortise Lock & Handle



HGMH-15
Glass Door Lock With Mortise Lock & Handle

- For Openable Door
- Material : Stainless Steel



HGMH-16
Strike Box with Handle

- For Openable Door
- Material : Stainless Steel



HGMH-17
Strike Box

- For Openable Door
- Material : Stainless Steel

Office & Residential Sliding System (Set)
HSL-LR1
 Sliding Long Roller

Available in these colors
 Black Golden Rose Gold

Sliding Roller Sliding Roller Stopper Stopper Floor Guide

Office & Residential Sliding System (Set)
HSL-A1 PVC
 Sliding Roller (PVC)

Available in these colors
 Black Golden Rose Gold

Sliding Roller Sliding Roller Stopper Stopper Floor Guide

Office & Residential Sliding System (Set)
HSL-A1
 Sliding Roller (S.S.)

Available in these colors
 Black Golden Rose Gold

Sliding Roller Sliding Roller Stopper Stopper Floor Guide

Office & Residential Sliding System (Set)
HSL-A2
 Sliding Roller

Available in these colors
 Black Golden Rose Gold

Sliding Roller Sliding Roller Stopper Stopper Floor Guide

Office & Residential Sliding System (Set)

HSL-A3
Sliding Roller

Available in these colors

Black Golden Rose Gold



Sliding Roller



Sliding Roller



Stopper



Stopper



Floor Guide



GLASS SLIDING SYSTEM WITH SOFT CLOSE

Specification :

- Stainless Steel Body
- For 10mm To 12 Mm Glass
- Nylon Wheels With Integrated Bearings
- Easy To Assemble & Dismantle The Glass
- Trouble Free Operation
- For Straight Glass Sliding Door
- Maximum Glass Weight : 60kgs/panel



HSL-SC-01

Glass Sliding System with Two Way Damping 60 Kg Weight Capacity
Material : SS Patch



HGSS-051

Glass Sliding Roller



HGSS-058

Glass Sliding Roller



HSL-A4
Track End Cover



HSL-A44
Curved Track Cover
(Left & Right)



HSL-A5
Wall to Track Clamp



HSL-A6
Glass to Track Clamp



HSL-ST-A1
Stopper



HSL-WTC-1B
Single Wall to Track
Connector



HSL-LK-W
Sliding Door Lock
(Wall to Glass)



HSL-LK-G
Sliding Door Lock
(Glass to Glass)



HSL-SH-10
Square Sliding Door
Handle



HSL-SH-20
Rectangle Sliding Door Handle



HSL-SH-30
Rectangle Sliding Door Handle



HSL-SH-50
Round Sliding Door Handle



HSL-SH-60
Round Sliding Door Handle



HSL-C1
Track for HSL-A3



HSL-B3
Aluminium Track (Door+Fix
Glass) for HSL-LR1, A1 & A2
Roller Available in : 2, 3 & 4mtr.



HSL-B1
Aluminium Track (Single
for HSL-LR1, A1 & A2 Roller)
Available in : 2, 3 & 4mtr.



HSL-B2
Aluminium Track (Double
for HSL-LR1, A1 & A2 Roller)
Available in : 2, 3 & 4mtr.



Available Color	
●	Black
●	Golden
●	Rose Gold



HSS - 401
Sliding Door Roller



HSS - 406
Wall To Track Connector



HSS - 403
Door Stopper



HSS - 403
Door Stopper



HSS - 410
Track Connector T-Type



HSS - 410
Glass to End Socket

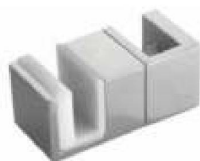

HSS - 404
Floor Guide 8mm to 10mm Glass



HSS - 402A
Track Supporter for Roller



HSS - 407
Track Connector 90

SHOWER SLIDING SYSTEM



Specification :

- Maximum Door Weight : 50 Kg
- Maximum Door Width : 750mm
- Maximum Door Height : 2000mm
- Maximum Glass Thickness : 8mm, 10mm

Available Color

- Black
- Golden
- Rose Gold



HSS-
Sliding Roller



HSS-AL-2
Tube Connector

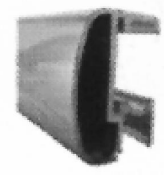

HSS-AL-3
Alu Rail



HSS-AL-4
Stopper

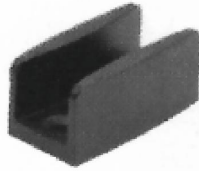

HSS-AL-5
Floor Guide

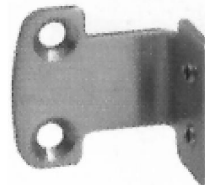

HSS-AL-6
Clip



HSS-AL-7
Round Sliding Door Handle

GLASS WEDGE SYSTEM

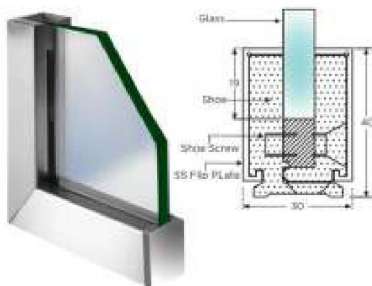

HRA-OGL-PR-22
Door Stopper



HRAOGL-PR-11
Door Stopper

Specification :

- Attached with ceiling, floor or wall
- Available in lengths of 2 meter or 3 meter
- Do not require any glass preparation
- Easy and simple installation of the glass
- Low maintenance cost
- High aesthetics value
- Highly cost effective
- Fast completion of projects can be achieved
- Finish: SSS clip-on cover
- End cap for better aesthetics



HPC-0101
Profile 'L' Connector



HSFS-1
Fixed Hinge



HSFS-2
Glass to Glass Center Hinge



HSFS-3
Center Hinge with Roller



HSFS-4
End Hinge with Roller



HSFS-5
Floor Fixed Hinge



HSFS-6
Glass to Glass Center Hinge with Lock



HSFS-7
Glass to Glass Center Hinge with Guide



HSFS-8
End Hinge with Guide



HSFS-9
Wall to Glass Hinge



HSFS-10
Floor Track Bottom (S.S.)



HSFS-11
Aluminium Track (Top)



FRAMELESS CENTER FOLDING SYSTEM



No need to grout in the floor with frameless center folding systems
Suitable for Mall, Showrooms, hotels and airport, etc.

Note :-

- Maximum weight per door : 70kg
- Maximum width per door : 900mm
- Maximum height per door : 2500mm
- Suitable for 8 to 10mm glass thickness

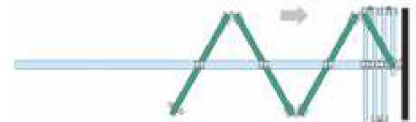

Optional



HCFS-101 R
Folding Door Roller



HCFS-101 H
Glass to Wall Hinge

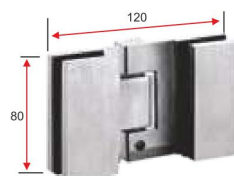

HCFS-102 H
Glass to Glass Hinge



HCFS-103 LK
Sliding Glass Door Lock



HCFS-104 K
Glass Door Knob

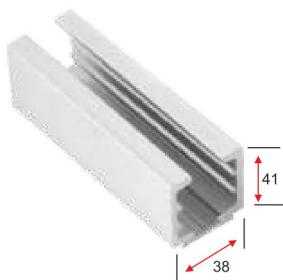

HCFS-105
Aluminium Track
Available in 2,3 & 4mtr.



HCFS-104 KS
Knob Sleeve

Frameless Center Folding System 4 Door Set

HCFS-101 R	2 Pcs
HCFS-101 H	2 Pcs
HCFS-102 H	6 Pcs
HCFS-104 K	4 Pcs
HCFS-105	1 Pc (3mtr.)
HCFS-104 KS	4 Pcs



Glass Folding System

HGFS-Z-1	1 Pc.
HGFS-Z-2	1 Pc.
HGFS-Z-3	2 Pcs.
HGFS-Z-4	1 Pc.
HGFS-Z-5	1 Pc.
HGFS-Z-6	2 Pcs.
HGFS-C-2	1 Pc. 3mtr.



HGFS-C-2
Track



HGFS-Z-1
Upper fixed door leaf (1/2 door leaf+63mm)



HGFS-Z-2
Lower fixed door leaf (1/2 door leaf+63mm)



HGFS-Z-3
Upper door strip (hinge + roller)



HGFS-Z-4
Lower door strip (hinge + surface bolt)



HGFS-Z-5
Upper end door leaf (1/2 door leaf+63mm)



HGFS-Z-6
Lower end door leaf (1/2 door leaf+63mm)



HGSS-33A
Office Sliding Roller Non
Counter Sunk Hole



HGSS-33B
Office Sliding Roller
Non Counter Sunk Hole



HGSS-33TH-G2
Rod to Glass Clamp Non
Counter Sunk Hole



HGSS-33TH
Wall to Rod Clamp



HGSS-DS-1R
Door Stopper



HGSS-DS-1L
Door Stopper



HGSS-33-GC
Connector (180°)
Glass to Glass

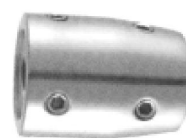

HSL-33B
Wall To Rod Holder



HGSS-FG
Floor Guide



HGSS-DS-22-RD
Connecting Tube Round
(25mm)



HAL-B-01
Galaxy Black Artificial
Marble Ledge



HAL-B-02
White Artificial Marble Ledge



HAL-B-02
Beige Artificial Marble Ledge



HAL-B-02
Dark Grey Mesh Artificial
Marble Ledge

Max Door Weight : 120kg

HYDRAULIC SLIDING SYSTEM



Aluminium Sliding Track

	Floor Guide	2 Pcs		Stopper	2 Pcs
	Sliding Handle	1 Pc		End Cap	2 Pcs
				Soft Close	2 Pcs



HHSS-01
Hydraulic Sliding Roller

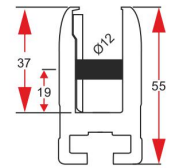
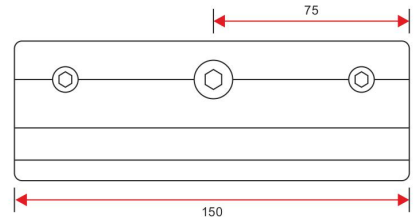

HSL-TFG-01
Glass Clip

Product Features :

1. Buffer self-closing overlapping door
2. Function : Bi-directional buffer closure
3. Angle : Open the door flat
4. Conventional surface treatment : Mirror surface, wire drawing

Telescopic Frameless Glass Doors Set 4Mtr.
1+3 Telescopic Frameless
1+4 Telescopic Frameless

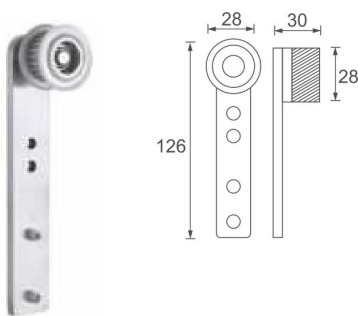

HSL-TFG-02
Long synchronous wheel

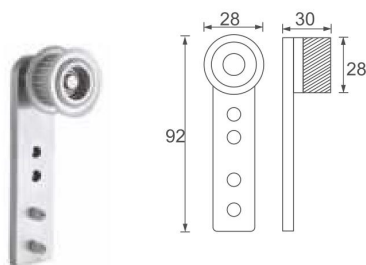

HSL-TFG-03
Short wheel

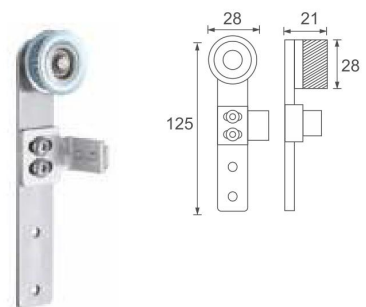

HSL-TFG-04
Long wheel



HFP-150
Fin Plate (150mm)



HFP-200
Fin Plate (200mm)



HFP-300
Fin Plate (300mm)



HFP-350
Fin Plate (350mm)



HFP-450
Fin Plate (450mm)



HSP-150
Splice Plate (150mm)



HSP-200
Splice Plate (200mm)



HSP-250
Splice Plate (250mm)



HSP-300
Splice Plate (300mm)



HSP-350
Splice Plate (350mm)



ARTICULATED ROUTEL



HSP-AFB-36-FL
Articulated Roudel (Flat Head)



HSP-AFB-36-CS
Articulated Roudel (Cunter Sunk Hole)



HSP-AFB-CS
Fixed Roudel (Cunter Sunk)



HSP-AFB-FL
Fixed Roudel (Flat Head)



HSP-AFB
Iron Assembly



HSP-AFB-36-FL
Point Head Roudel

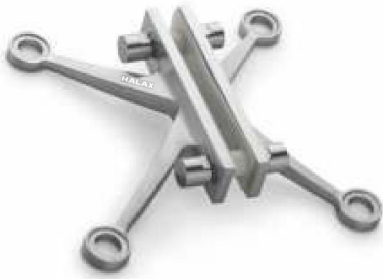

HSF-4
Four Way Spider SS 304



HSF-44
Two Way Spider SS 304



HSF-2
Two Way Spider 90° SS 304



HSF-22
One Way Spider (Wall Mounted) SS 304



HSF-B-1
One Way Spider without
Fin 160mm



HSF-B-2-90
Two Way Spider 90° without
Fin 220mm



HSF-B-2-180
Two Way Spider 180° without
Fin 220mm



HSF-B3
Three Way Spider without Fin 220mm



HSF-B4
Four Way Spider without Fin 220mm



HSF-B90
Four Way Spider without Fin 90°



HSF-PHS-4
Four Way Spider with Fin SS 316



HSF-PHS-44
Two Way Spider 90° (Wall Mounted)
with Fin SS 316



HSF-PHS-2
Two Way Spider 180° with Fin SS 316



HSF-PHS-22
One Way Spider 90° (Wall Mounted)
with Fin SS 316





HCF-1
Wall to Glass



HCF-2
Rod to Glass



HCF-3
Wall to Rod



HCF-11
Wall to Glass Connector



HCF-22
Adjustable Glass
Connector for HCF-44



HCF-33
Wall Connector for
HCF-44



HCF-44
Threaded Sleeve for
HCF-66



HCF-55
Canopy Fitting for
Two Glass Joiner



HCF-66
Connecting Rod
for Canopy (SS 304)

HRA-2
Spigot



HRA-101
Spigot



HSL-3
Glass to Hand Rail (Square)



HRAC-44-WH
Wall to Hand Rail



HRA-5
Glass to Hand Rail (Round)



HRA-6
U Shape Railing Connector



HRA-7
U Shape Railing Connector



RA-9
Railing Stud



HRA-50
Single Groove Round Pipe



HRA-60
Single Slotted



HRA-37
Glass Adjustable Stud



HGP-402
Wall Connecting Profile
Available in 3 & 5 Mtr.





HDL-11 FP G2G & W2G STD
 Digital lock High-End Intelligent Lock
 Glass to Glass & Wall to Glass



HDL-13 FP-SSL
 Slim Smart Lock



HDL-12 FP-SDL
 Digital Lock Smart Sliding Door Lock
 Glass to Glass & Wall to Glass

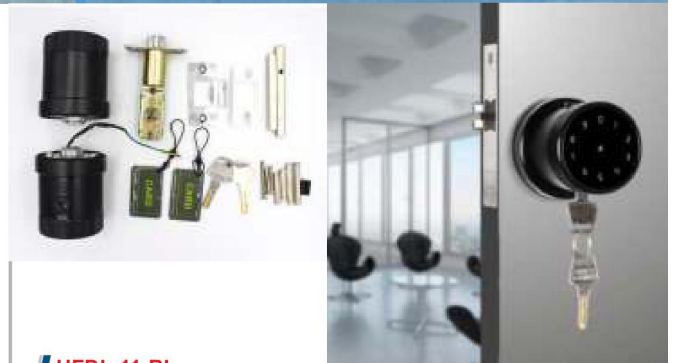

HFDL-11-BL
 Finger Print & Digital Door Locks



- APP Unlock
- Fingerprint Unlock
- PIN Code Unlock
- Key Unlock

HFDL-22-BL
 Finger Print & Digital Door Locks

Controller Dimensions	85x124x600mm
Weight	12kg
Maximum leaf weight	Table
Open range	70o ~ 115o
Closing speed	10 ~ 43cm / s
Door hold time	0.5 ~ 10 seconds
Main Power	AC220V ~ 250V, 50/60Hz
Maximum current	1A
Maximum motor power	55W
Wait Power	14W
Fuse	Minimum 3.5A Slow
Operating Temperature	-30°C ~ +50°C

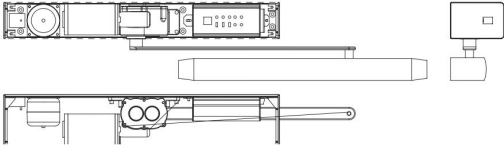

HSDC-1
Automatic openable door operator

Door Sensor



GLASS LIFTERS



HGL-2
Glass Lifter with Two Cups



HGL-2H
Glass Lifter with Two Cups (Heavy)

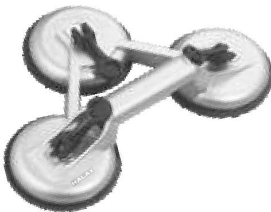

HGL-3
Glass Lifter with Three Cups



HGL-3H
Glass Lifter with Three Cups (Heavy)



HGL-H
Glass Lifter with Handle

SLIM PROFILE SYSTEM



HVR-42 / HR-42
10 X 42 Vertical &
Horizontal

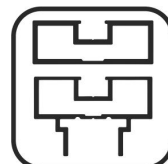

HVR-45 / HR-45
16 X 45 Vertical &
Horizontal



HBFH-01
Butter Fly

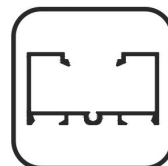

HFVR-45
25 X 45 Vertical
Fix Profile

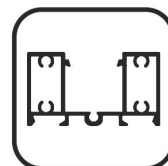

HFVR-H-45
25 X 45 Fix
Heavy Vertical

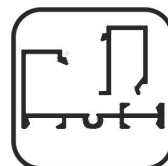

HFHR-45-01/02
25 X 45 Horizontal Fix
Outer Cap Profile

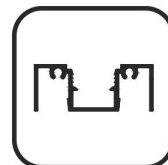

HTLC-VRF-01
16 X 45 VERTICAL
FIX PROFILE



HTLC-HRF-01
HORIZONTAL FIX
OUTER PROFILE

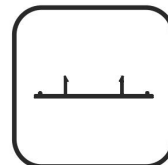

HTLC-VR-EC-01
16 X 45 VERTICAL
FIX END CAP PROFILE

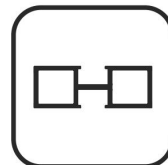

HTLC-DRD-01
16 X 45 DIVIDER



HVR-H2
HANDLE WITH LATCH



HMGL-12G
LOCK WITH HANDLE



HMGL-12B
LOCK WITH HANDLE



HTLC-SK-02
16 X 16 STICKON

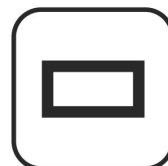

HTLC-SK-01
10 X 20 STICKON



HLJ-42/45
L-JOINTER



HSH-AL-01
Shower hinge wall to glass



HSH-AL-02
Shower hinge wall to glass



HTLC-SL-11
Sliding Lock with Knob

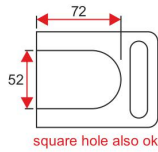

HMGL-12BM
Glass Door Lock
16 x 45 use to Slim Profile System

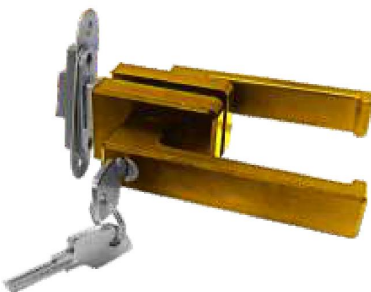
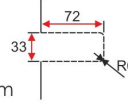

HMGL-12G
Glass Door Lock
16 x 45 use to Slim Profile System

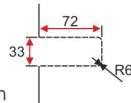

HMGL-13BM
Glass Door Lock
10 x 42 use to Slim Profile System

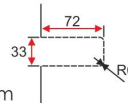

HSGL-14BM
Style Door Lock

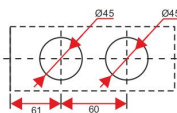

HSGL-14ST-BM
Style Door Strike Box

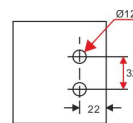

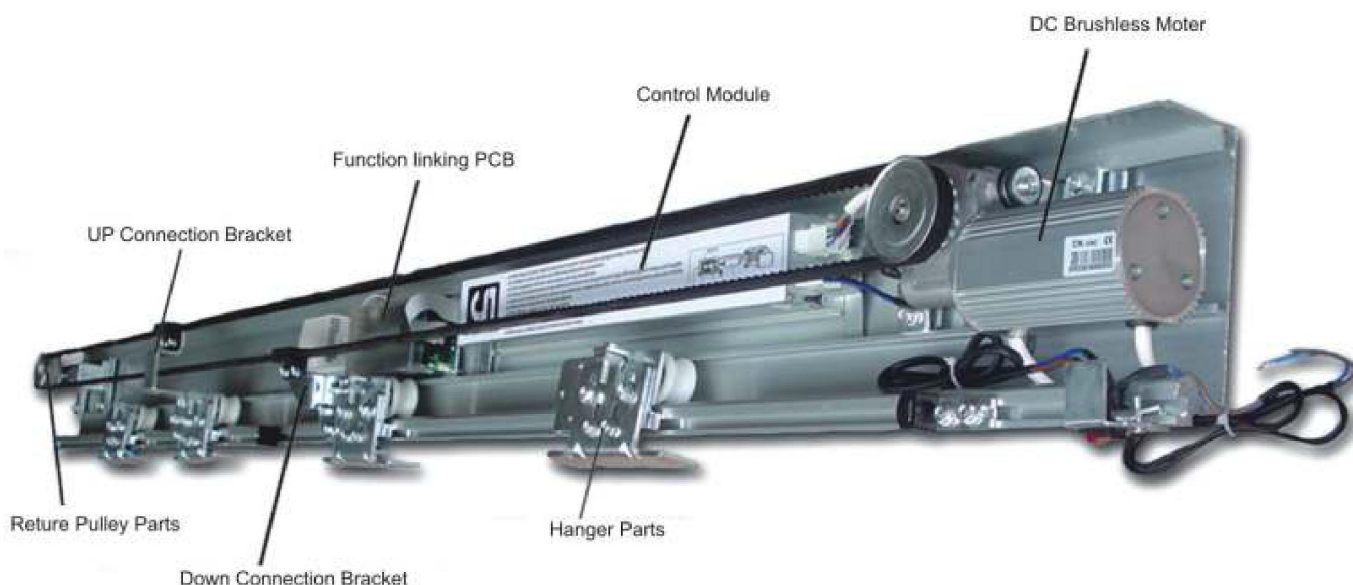

HASD-1

Automatic Sensor Door

Specification :

- Intelligent control system.
- Drive equipment with low noise.
- Advance brush less motor and worm wheel reducer are integrated.
- Special self-locking function without any addition components.
- With different triggered opening modes.
- Double door interlock function.
- Optional power supply backup to ensure the normal operation.
- When door is closed, it shall be locked and kept closed.
- Apply to doors for garage, usage of anti-ratiation for hospitals, warehouses, science and technology factories, barriers-free space, commercial building, shopping mall, etc.
- Track size : 4200mm/6400mm.





Glass Architectural Hardware



Designed by #7838783051



E-mail : info@halax.in
www.halax.in